

# 3535PKG

## Dimensions

Unit : mm  
Tolerance :  $\pm 0.1$

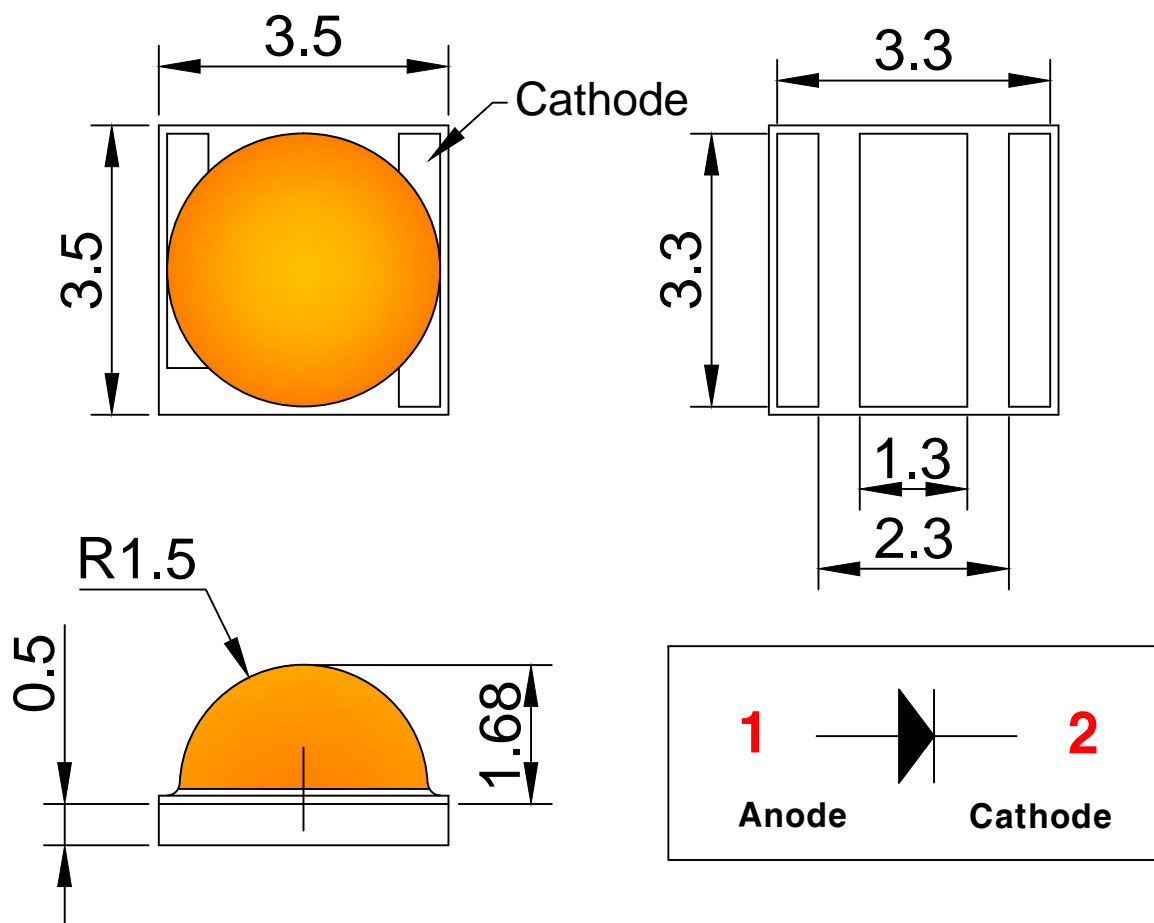

## Soldering Pad

Unit : mm  
Tolerance :  $\pm 0.1$

