

Features

- Package : Top View LED in Slug Type
- Size : 3.0(L) X 1.4(W) X 0.75(T) mm
- Viewing Angle : $2\theta_{1/2} = 120\text{deg}$
- Color : White
- CRI : Min. 95, Max.99

Description

AT14SNW-XL Series are white LEDs devices which are materialized by combining blue chip and special phosphors. With the distinct technology of phosphor combination, ALLIX's AT Series can make high CRI values.

Applications

- Coupling into light guides
- Optical indicator
- Interior automotive lighting
- Indoor General Lighting
- Retrofits and Fixtures

SMD 3014 Top View LED(White)
Device No. : AT14SNW-A□□□□-XL



Table of Contents

Part Number Description	-----	p2
Specifications	-----	p3
Rank	-----	p4
Characteristics Diagrams	-----	p7
Chromaticity Diagram	-----	P11
Color Rank	-----	p16
Results of Reliability Test	-----	p29
Soldering Cautions	-----	p30
Precaution	-----	p31
Outline Dimension	-----	p36
Composition of Package	-----	p37
Taping	-----	P38
Packing Structure	-----	p40



1. SMD Part Number Description

A T 14S N W – A □ □ □ □ - (XL)

A	ALLIX			
T	External Shape T : Top View(SMD)			
14S	Package Size			
	SMD	28S: 2835 Slug	35B : 3528 Bending	35S:3535 Slug
		14S:3014 Slug	30S:3030 Slug	54B: 5450 Bending
		54S: 5450 Slug	56S : 5630 Slug	92S: 9280 Slug
N	ESD Protection Z : Zener Diode, N : Non Zener Diode			
W	Emission Color W(white) R(red) G(green) B(blue) I(infrared) U(ultra violet) A(amber) Y(yellow) S(Skyblue) O(orange) P(pink) F(R,G,B Full)			
A	Color Rendering Index A : High (Ra≥90), B : Medium (Ra=80~89), C : Low (Ra≤79)			
<input type="checkbox"/>	Color Rank(CCT) A:10,000K, B:8,000K, C:6,500K, D:5,700K, E:5,000K, F:4,500K, G:4,000K, H:3,500K, I:3,000K, J:2,700K, K:2,500K, L:2,200K, M:2,000K			
<input type="checkbox"/>	I_v (mcd), Φ_v (lm) Rank			
<input type="checkbox"/>	XL : XENOLED™ II			



2. Specifications

■ Absolute Maximum Ratings

($T_a=25^{\circ}\text{C}$)

Parameter	Symbol	Absolute Maximum Rating	Unit	Remark
Power Dissipation	P_D	340	mW	
Forward Current	I_F	100	mA	
Pulse Forward Current ⁽¹⁾	I_{FP}	300	mA	
Reverse Voltage	V_R	5	V	
Operating Temperature	T_{opr}	-40 to +85	$^{\circ}\text{C}$	
Storage Temperature	T_{stg}	-40 to +100	$^{\circ}\text{C}$	
Junction Temperature	T_J	125	$^{\circ}\text{C}$	
Temperature during Packaging (reflow)	T_{slid}	< 5sec @260 $^{\circ}\text{C}$	sec	

*Note

1) Duty ratio = 1/10, pulse width = 10msec

■ Initial Electrical/Optical Characteristics

($T_a=25^{\circ}\text{C}$)

Parameter	Symbol	Condition	Min.	Typ.	Max.	Unit
Forward Voltage ⁽¹⁾	V_F	$I_F = 60\text{mA}$	-	3.3	3.8	V
Luminous Intensity ⁽²⁾	I_V	$I_F = 60\text{mA}$	-	4,000	-	mcd
Luminous Flux	Φ_V	$I_F = 60\text{mA}$	-	14.3	-	lm
Optical Efficiency	η_{elc}	$I_F = 60\text{mA}$	-	72	-	lm/W
Color Temperature (=5,000K)	CCT	$I_F = 60\text{mA}$	-	5,000	-	K
Color Rendering Index	Ra	$I_F = 60\text{mA}$	95	-	-	
Reverse Current	I_R	$V_R = 5\text{V}$	-	-	1	μA

*Note

1) Forward Voltage Measurement allowance is $\pm 10\%$

2) Luminous Intensity Measurement allowance is $\pm 5\%$, Measuring equipment : OPI-100 (Optel System)



3. Rank

CCT Range (K)	CRI		Base Order Codes Min. Luminous Flux @60mA			ANSI Rank	Device
	Min	Typ	Group	Flux(cd) @25°C	Flux(lm) @ 25°C	Chromaticity Region	
10,000K	90	93	K0	2.5-3.0	7.3-8.7	A	AT14SNW-AA□K0-XL
			L0	3.0-3.5	8.7-10.2		AT14SNW-AA□L0-XL
			M0	3.5-4.0	10.2-11.6		AT14SNW-AA□M0-XL
			N0	4.0-4.5	11.6-13.1		AT14SNW-AA□N0-XL
			O0	4.5-5.0	13.1-14.5		AT14SNW-AA□O0-XL
8,000K	92	93	K0	2.5-3.0	7.3-8.7	B	AT14SNW-AB□K0-XL
			L0	3.0-3.5	8.7-10.2		AT14SNW-AB□L0-XL
			M0	3.5-4.0	10.2-11.6		AT14SNW-AB□M0-XL
			N0	4.0-4.5	11.6-13.1		AT14SNW-AB□N0-XL
			O0	4.5-5.0	13.1-14.5		AT14SNW-AB□O0-XL
6,500K	95	96	M0	3.5-4.0	10.2-11.6	C	AT14SNW-AC□M0-XL
			N0	4.0-4.5	11.6-13.1		AT14SNW-AC□N0-XL
			O0	4.5-5.0	13.1-14.5		AT14SNW-AC□O0-XL
			P0	5.0-5.5	14.5-16.0		AT14SNW-AC□P0-XL
			Q0	5.5-6.0	16.0-17.4		AT14SNW-AC□Q0-XL
5,700K	95	96	M0	3.5-4.0	10.2-11.6	D	AT14SNW-AD□M0-XL
			N0	4.0-4.5	11.6-13.1		AT14SNW-AD□N0-XL
			O0	4.5-5.0	13.1-14.5		AT14SNW-AD□O0-XL
			P0	5.0-5.5	14.5-16.0		AT14SNW-AD□P0-XL
			Q0	5.5-6.0	16.0-17.4		AT14SNW-AD□Q0-XL
5,000K	95	96	M0	3.5-4.0	10.2-11.6	E	AT14SNW-AE□M0-XL
			N0	4.0-4.5	11.6-13.1		AT14SNW-AE□N0-XL
			O0	4.5-5.0	13.1-14.5		AT14SNW-AE□O0-XL
			P0	5.0-5.5	14.5-16.0		AT14SNW-AE□P0-XL
			Q0	5.5-6.0	16.0-17.4		AT14SNW-AE□Q0-XL



Production Specification

AT14SNW-XL Series

CCT Range (K)	CRI		Base Order Codes Min. Luminous Flux @60mA			ANSI Rank	Device
	Min	Typ	Group	Flux(cd) @25°C	Flux(lm) @ 25°C	Chromaticity Region	
4,500K	95	96	M0	3.5-4.0	10.2-11.6	F	AT14SNW-AF□M0-XL
			N0	4.0-4.5	11.6-13.1		AT14SNW-AF□N0-XL
			O0	4.5-5.0	13.1-14.5		AT14SNW-AF□O0-XL
			P0	5.0-5.5	14.5-16.0		AT14SNW-AF□P0-XL
			Q0	5.5-6.0	16.0-17.4		AT14SNW-AF□Q0-XL
4,000K	95	97	M0	3.5-4.0	10.2-11.6	G	AT14SNW-AG□M0-XL
			N0	4.0-4.5	11.6-13.1		AT14SNW-AG□N0-XL
			O0	4.5-5.0	13.1-14.5		AT14SNW-AG□O0-XL
			P0	5.0-5.5	14.5-16.0		AT14SNW-AG□P0-XL
			Q0	5.5-6.0	16.0-17.4		AT14SNW-AG□Q0-XL
3,500K	95	97	K0	2.5-3.0	7.3-8.7	H	AT14SNW-AH□K0-XL
			L0	3.0-3.5	8.7-10.2		AT14SNW-AH□L0-XL
			M0	3.5-4.0	10.2-11.6		AT14SNW-AH□M0-XL
			N0	4.0-4.5	11.6-13.1		AT14SNW-AH□N0-XL
			O0	4.5-5.0	13.1-14.5		AT14SNW-AH□O0-XL
3,000K	95	97	K0	2.5-3.0	7.3-8.7	I	AT14SNW-AI□K0-XL
			L0	3.0-3.5	8.7-10.2		AT14SNW-AI□L0-XL
			M0	3.5-4.0	10.2-11.6		AT14SNW-AI□M0-XL
			N0	4.0-4.5	11.6-13.1		AT14SNW-AI□N0-XL
			O0	4.5-5.0	13.1-14.5		AT14SNW-AI□O0-XL
2,700K	95	97	K0	2.5-3.0	7.3-8.7	J	AT14SNW-AJ□K0-XL
			L0	3.0-3.5	8.7-10.2		AT14SNW-AJ□L0-XL
			M0	3.5-4.0	10.2-11.6		AT14SNW-AJ□M0-XL
			N0	4.0-4.5	11.6-13.1		AT14SNW-AJ□N0-XL
			O0	4.5-5.0	13.1-14.5		AT14SNW-AJ□O0-XL



Production Specification

AT14SNW-XL Series

CCT Range (K)	CRI		Base Order Codes Min. Luminous Flux @60mA			ANSI Rank	Device
	Min	Typ	Group	Flux(cd) @25°C	Flux(lm) @ 25°C	Chromaticity Region	
2,500K	95	97	K0	2.5-3.0	7.3-8.7	K	AT14SNW-AK□K0-XL
			L0	3.0-3.5	8.7-10.2		AT14SNW-AK□L0-XL
			M0	3.5-4.0	10.2-11.6		AT14SNW-AK□M0-XL
			N0	4.0-4.5	11.6-13.1		AT14SNW-AK□N0-XL
			O0	4.5-5.0	13.1-14.5		AT14SNW-AK□O0-XL
2,200K	95	97	I0	1.5-2.0	4.4-5.8	L	AT14SNW-AL□I0-XL
			J0	2.0-2.5	5.8-7.3		AT14SNW-AL□J0-XL
			K0	2.5-3.0	7.3-8.7		AT14SNW-AL□K0-XL
			L0	3.0-3.5	8.7-10.2		AT14SNW-AL□L0-XL
			M0	3.5-4.0	10.2-11.6		AT14SNW-AL□M0-XL
2,000K	95	97	I0	1.5-2.0	4.4-5.8	M	AT14SNW-AM□I0-XL
			J0	2.0-2.5	5.8-7.3		AT14SNW-AM□J0-XL
			K0	2.5-3.0	7.3-8.7		AT14SNW-AM□K0-XL
			L0	3.0-3.5	8.7-10.2		AT14SNW-AM□L0-XL
			M0	3.5-4.0	10.2-11.6		AT14SNW-AM□M0-XL



4. Characteristics Diagrams

($T_a=25^{\circ}\text{C}$)

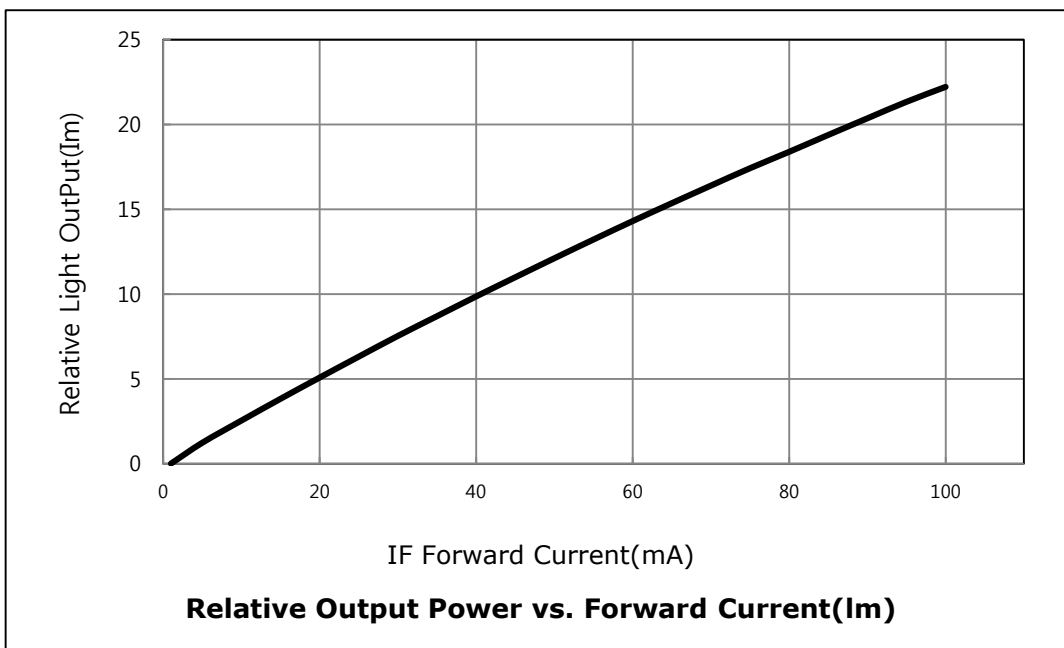
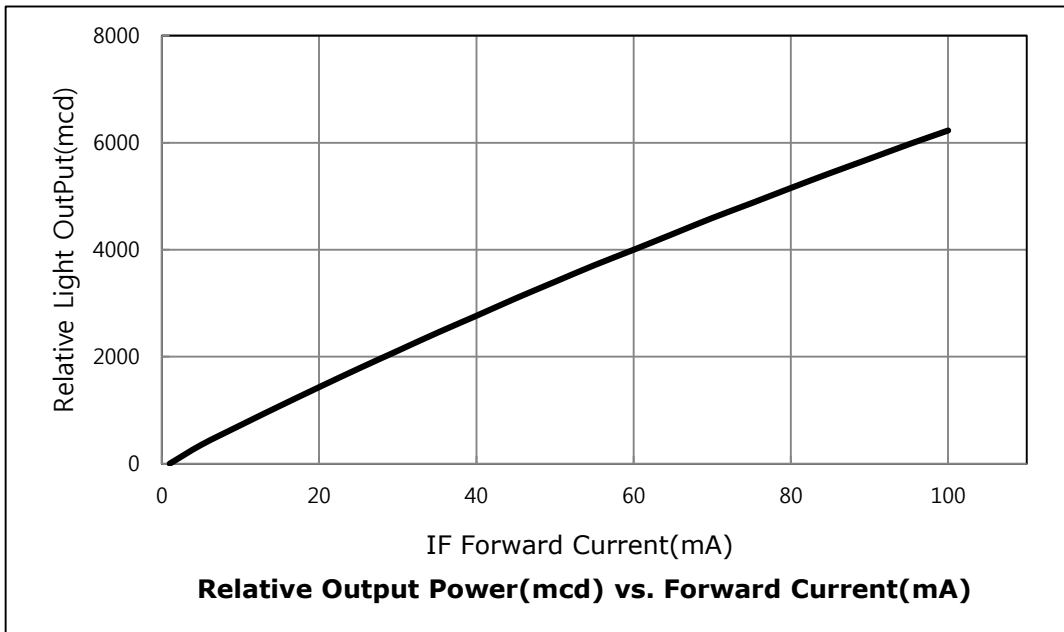

($T_a=25^\circ\text{C}$)

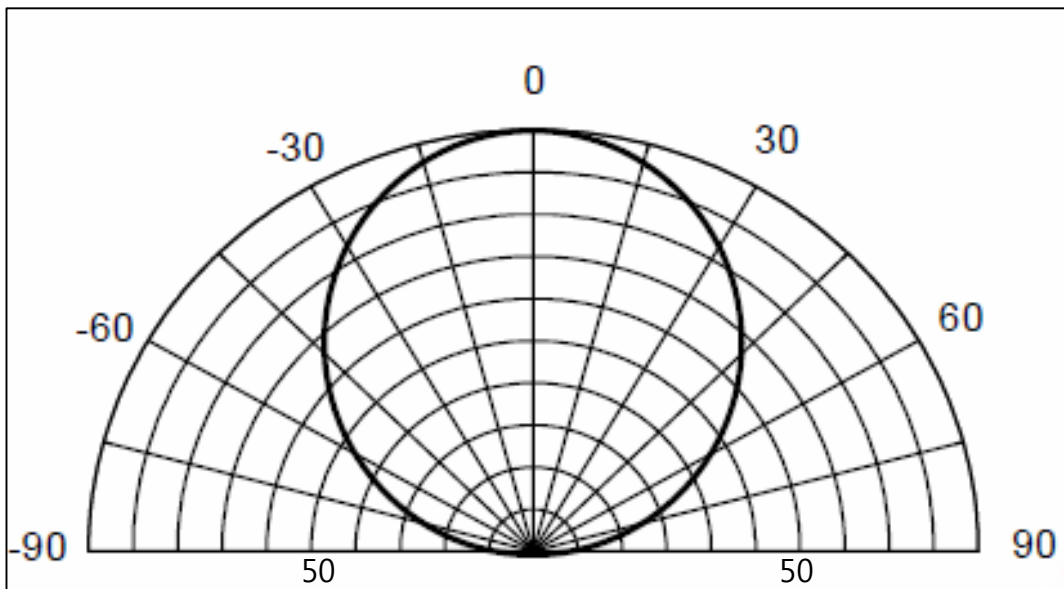
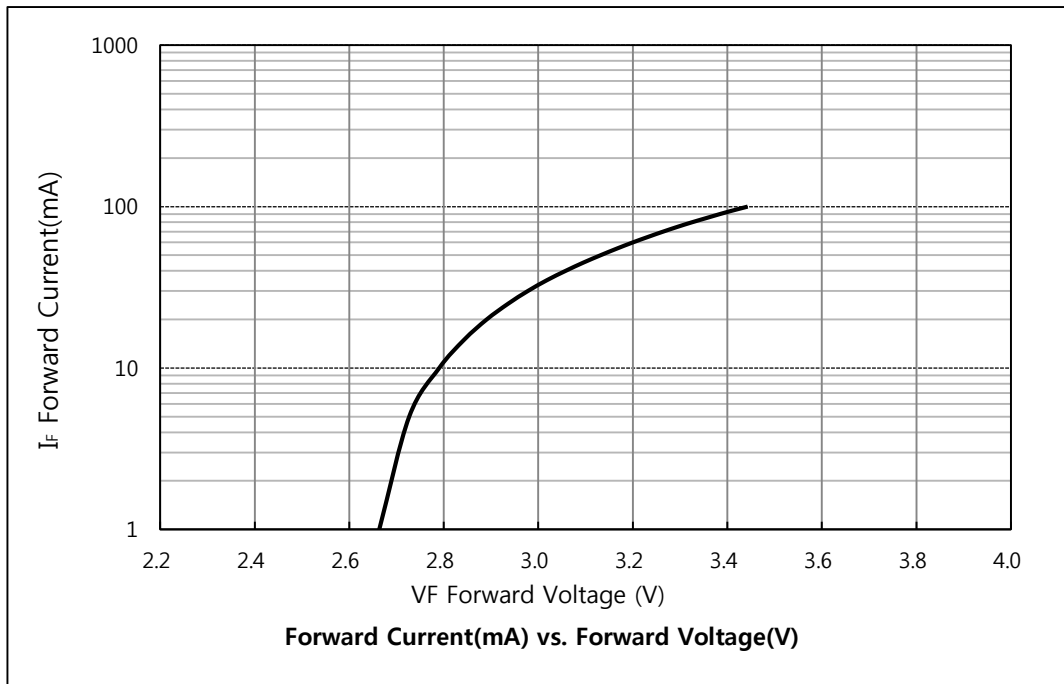

Directivity

($T_a=25^{\circ}\text{C}$)

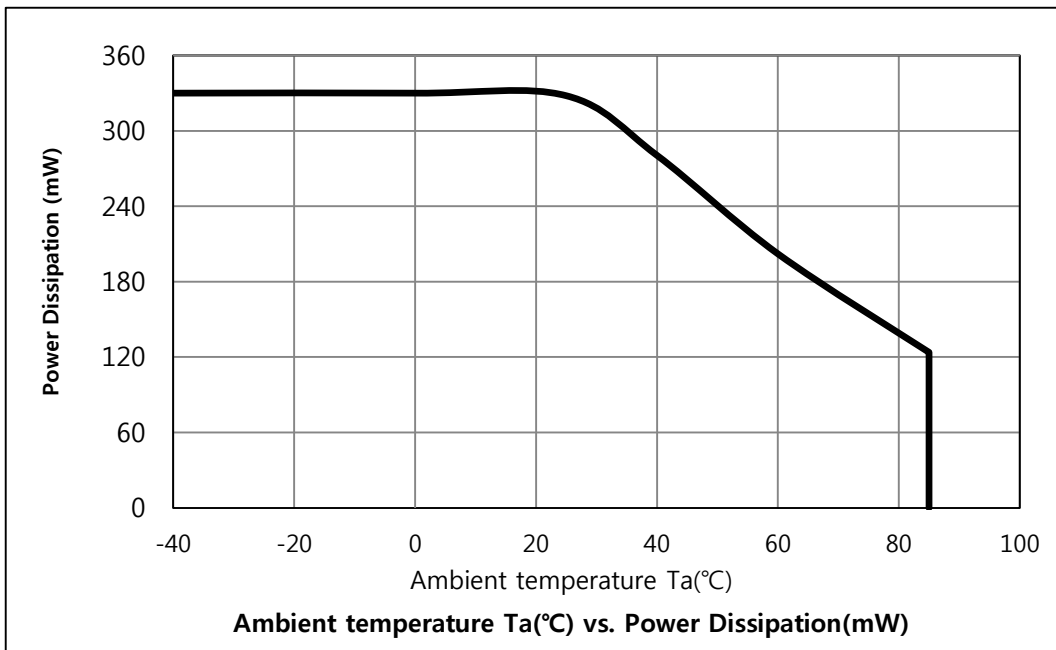
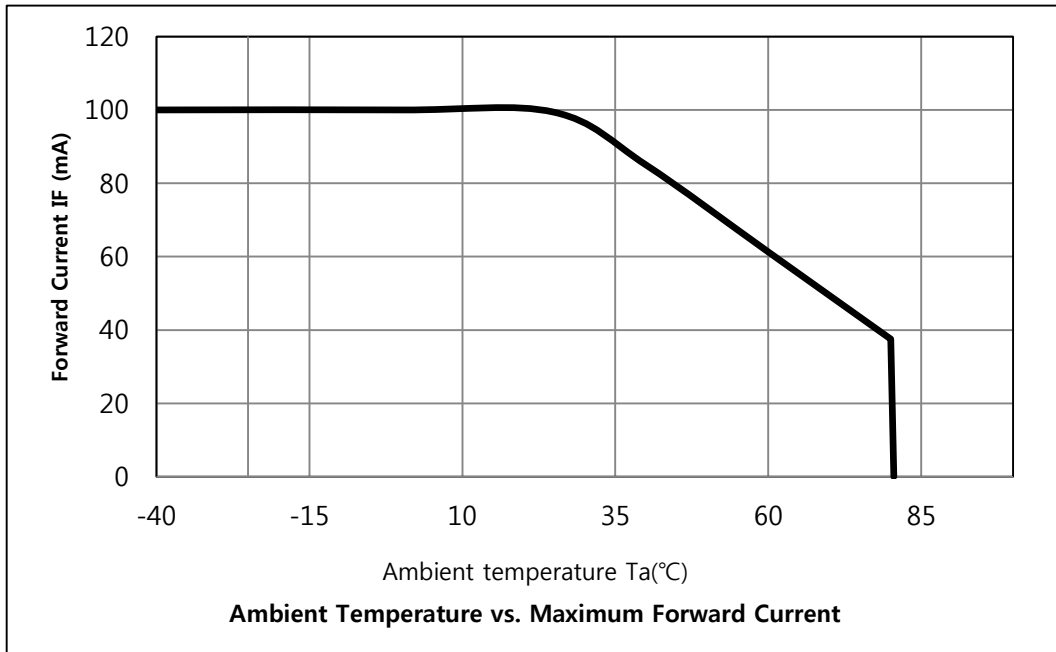

($T_a=25^\circ\text{C}$)

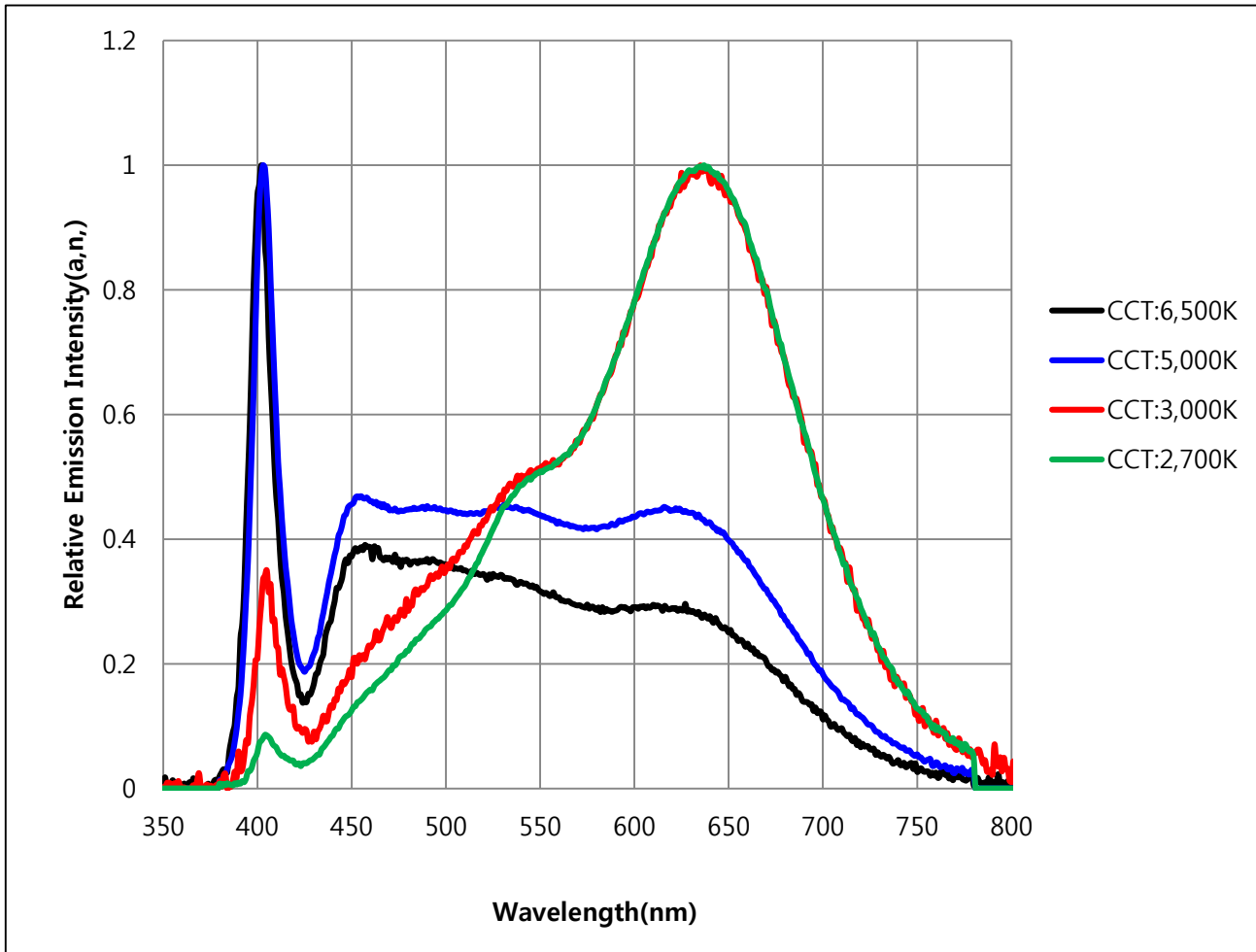

Color Spectrum

5. Chromaticity Diagram

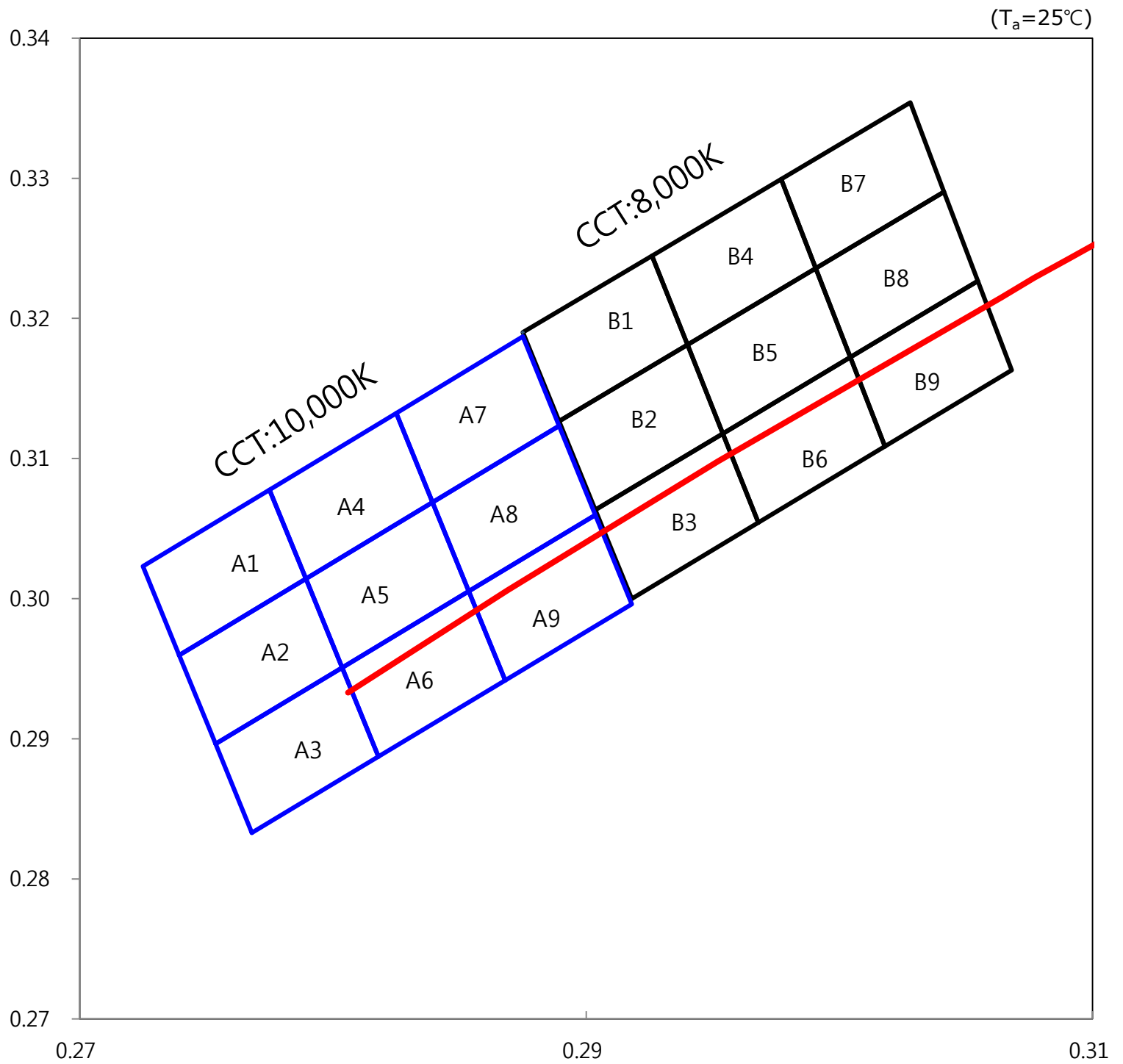

($T_a=25^\circ\text{C}$)

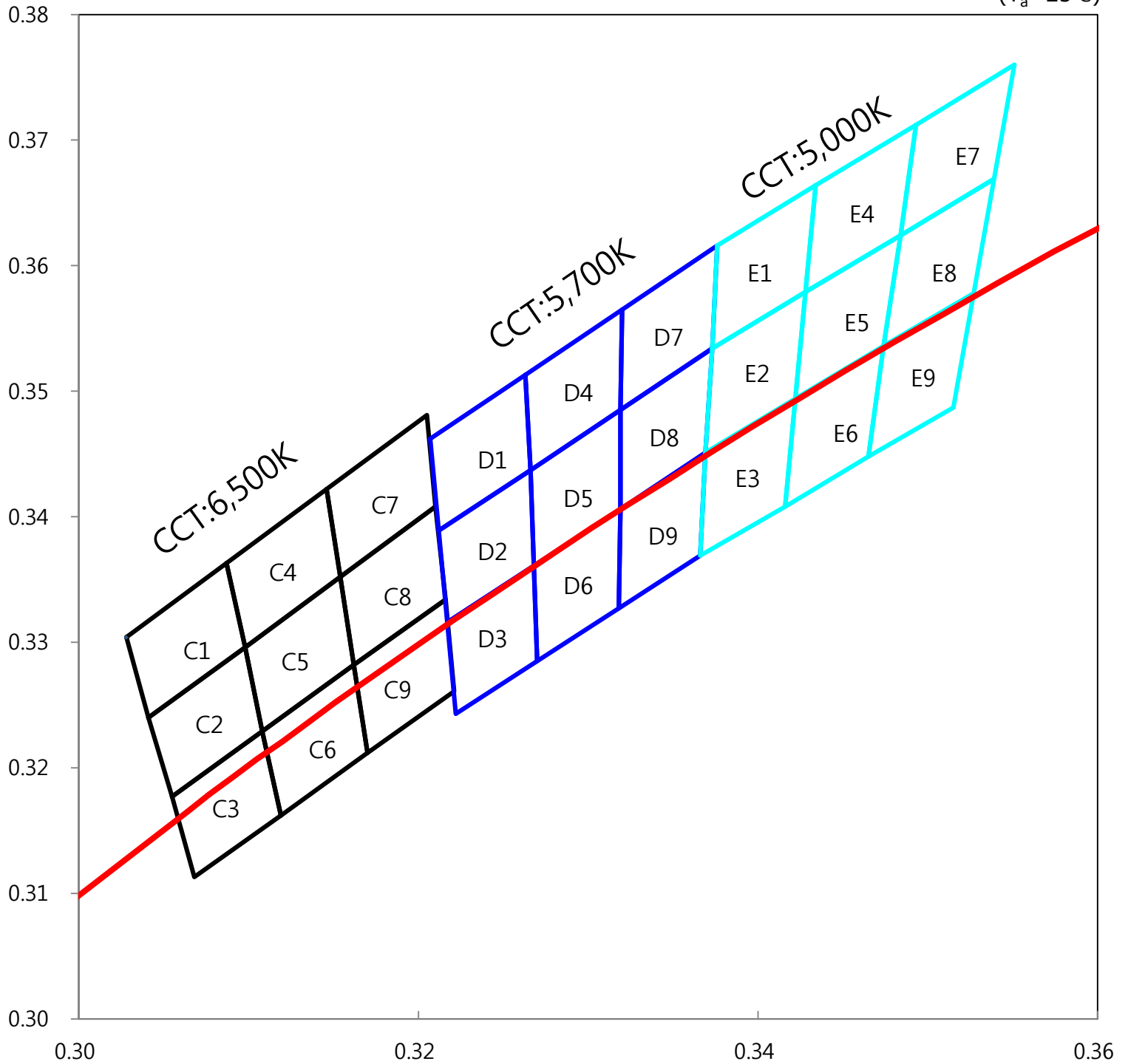

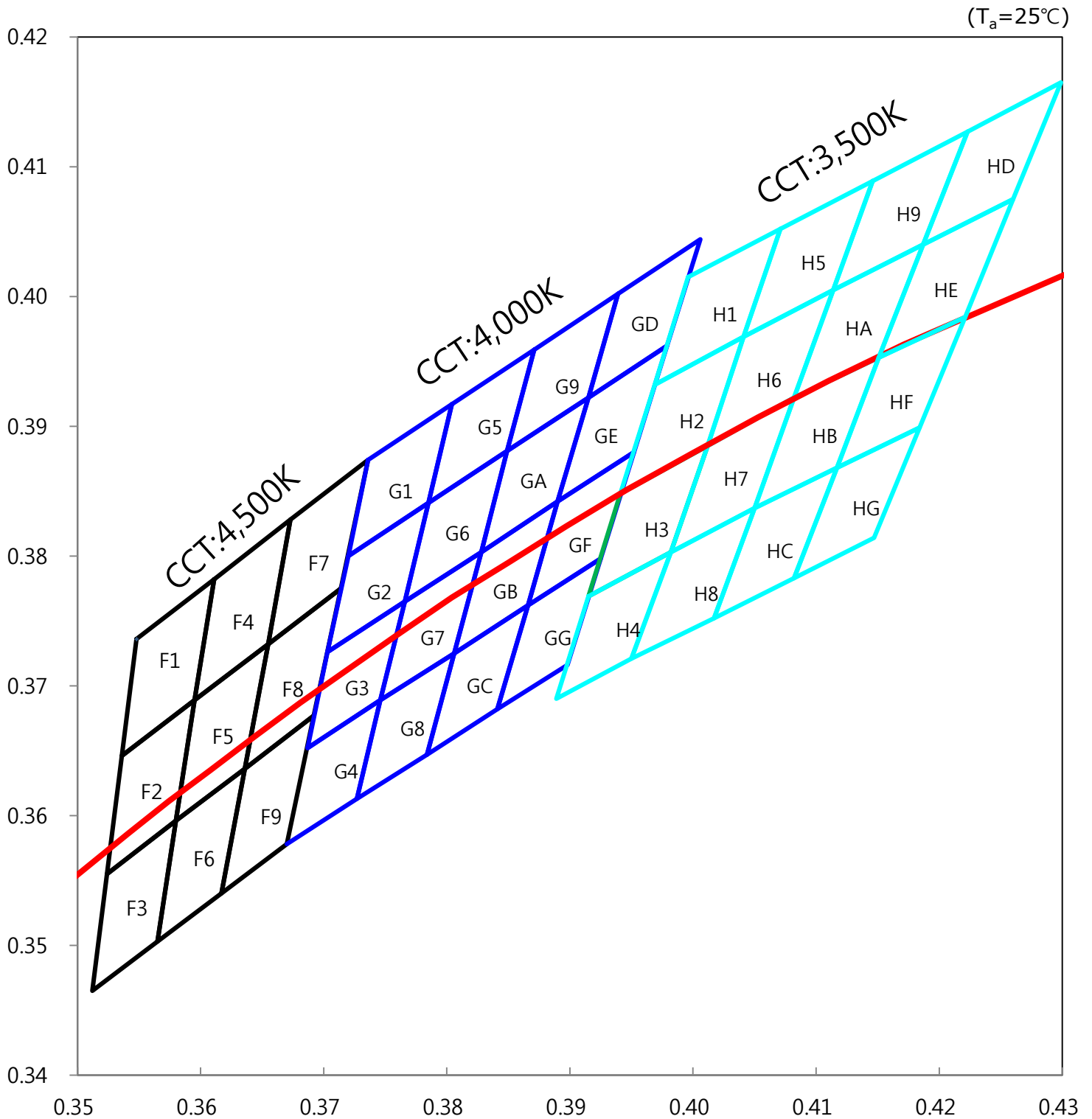

Production Specification

AT14SNW-XL Series

($T_a=25^\circ\text{C}$)

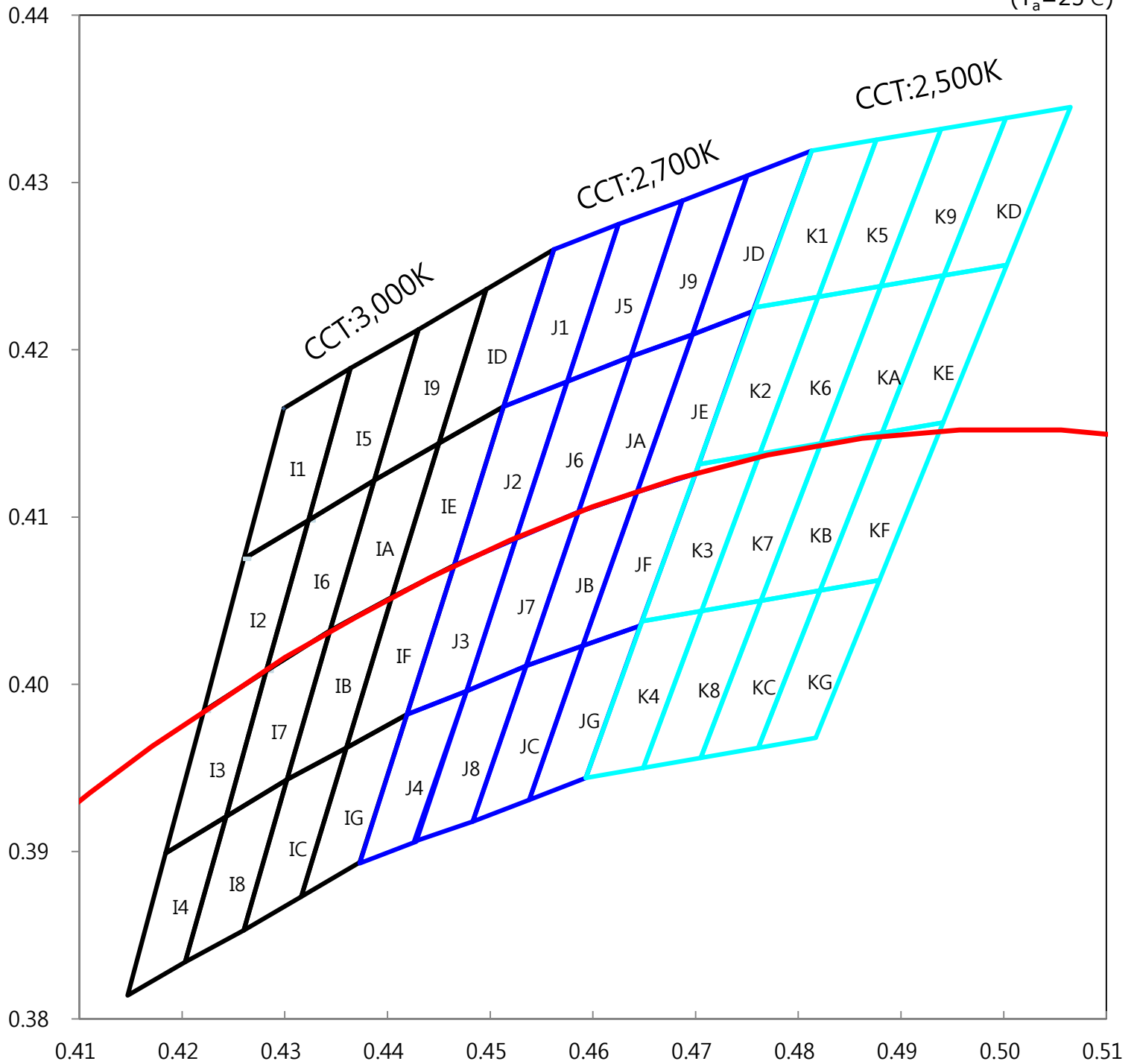

Production Specification

AT14SNW-XL Series

($T_a=25^\circ\text{C}$)

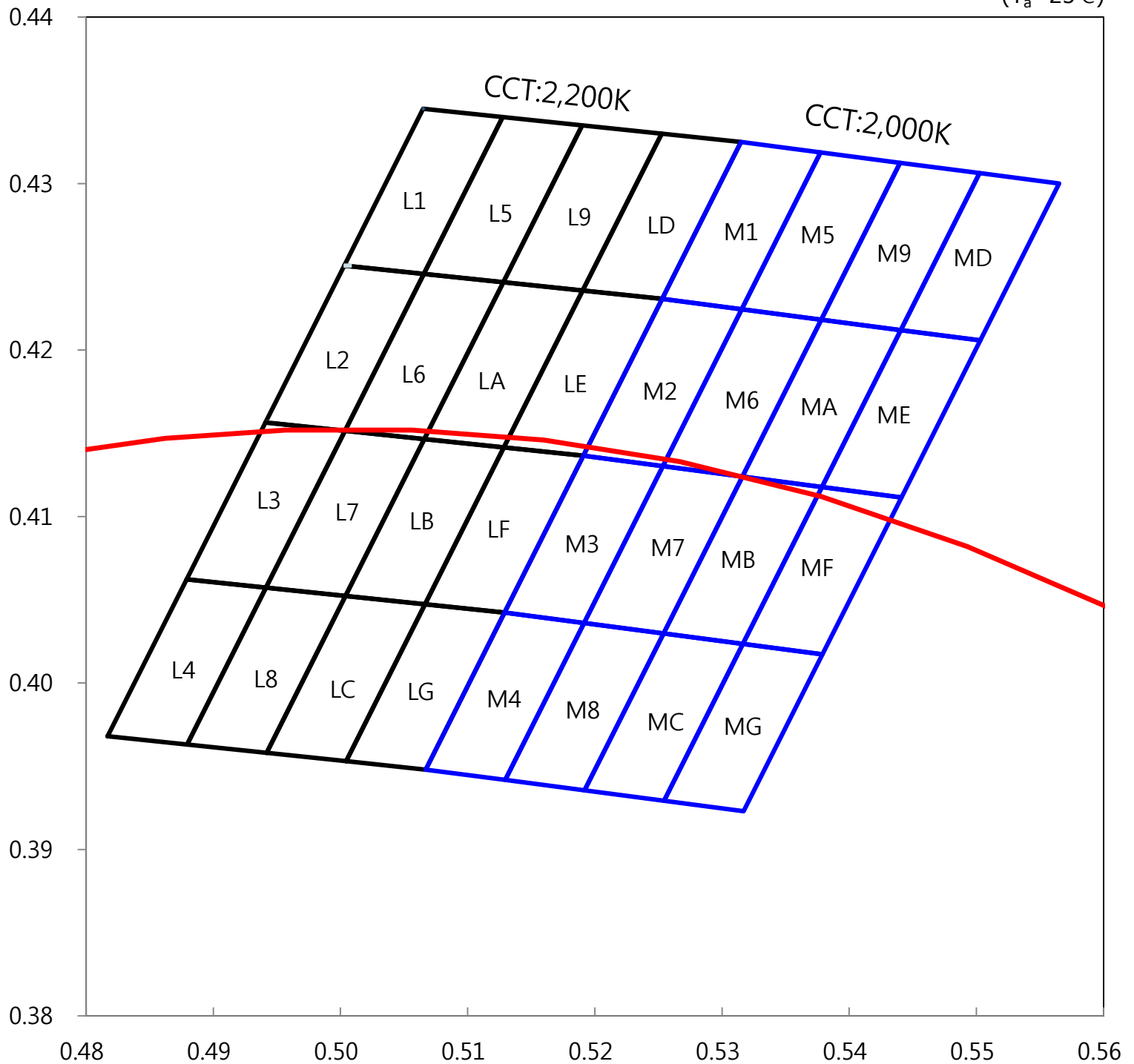

6. Color Rank

($I_F=60\text{mA}$, $T_a=25^\circ\text{C}$)

CCT : 10,000K					
A1		A2		A3	
CIE-x	CIE-y	CIE-x	CIE-y	CIE-x	CIE-y
0.2739	0.2910	0.2754	0.2846	0.2768	0.2783
0.2725	0.2973	0.2739	0.2910	0.2754	0.2846
0.2775	0.3028	0.2789	0.2964	0.2804	0.2901
0.2789	0.2964	0.2804	0.2901	0.2818	0.2837
A4		A5		A6	
CIE-x	CIE-y	CIE-x	CIE-y	CIE-x	CIE-y
0.2789	0.2964	0.2804	0.2901	0.2818	0.2837
0.2775	0.3028	0.2789	0.2964	0.2804	0.2901
0.2825	0.3082	0.2839	0.3019	0.2854	0.2955
0.2839	0.3019	0.2854	0.2955	0.2868	0.2892
A7		A8		A9	
CIE-x	CIE-y	CIE-x	CIE-y	CIE-x	CIE-y
0.2839	0.3019	0.2854	0.2955	0.2868	0.2892
0.2825	0.3082	0.2839	0.3019	0.2854	0.2955
0.2875	0.3137	0.2889	0.3073	0.2904	0.3010
0.2889	0.3073	0.2904	0.3010	0.2918	0.2946

*Note

- 1) Chromaticity coordinates measurement allowance is ± 0.01 .
- 2) The Chromaticity coordinates refer to CIE 1931 chromaticity diagram.



($I_F=60\text{mA}$, $T_a=25^\circ\text{C}$)

CCT : 8,000K					
B1		B2		B3	
CIE-x	CIE-y	CIE-x	CIE-y	CIE-x	CIE-y
0.2889	0.3077	0.2904	0.3013	0.2918	0.2950
0.2875	0.3140	0.2889	0.3077	0.2904	0.3013
0.2926	0.3195	0.2940	0.3131	0.2954	0.3068
0.2940	0.3131	0.2954	0.3068	0.2968	0.3004
B4		B5		B6	
CIE-x	CIE-y	CIE-x	CIE-y	CIE-x	CIE-y
0.2940	0.3131	0.2954	0.3068	0.2968	0.3004
0.2926	0.3195	0.2940	0.3131	0.2954	0.3068
0.2977	0.3249	0.2991	0.3186	0.3004	0.3122
0.2991	0.3186	0.3004	0.3122	0.3018	0.3059
B7		B8		B9	
CIE-x	CIE-y	CIE-x	CIE-y	CIE-x	CIE-y
0.2991	0.3186	0.3004	0.3122	0.3018	0.3059
0.2977	0.3249	0.2991	0.3186	0.3004	0.3122
0.3028	0.3304	0.3041	0.3240	0.3055	0.3177
0.3041	0.3240	0.3055	0.3177	0.3068	0.3113

*Note

- 1) Chromaticity coordinates measurement allowance is ± 0.01 .
- 2) The Chromaticity coordinates refer to CIE 1931 chromaticity diagram.



($I_F=60\text{mA}$, $T_a=25^\circ\text{C}$)

CCT : 6,500K					
C1		C2		C3	
CIE-x	CIE-y	CIE-x	CIE-y	CIE-x	CIE-y
0.3028	0.3304	0.3041	0.3240	0.3055	0.3177
0.3087	0.3363	0.3098	0.3296	0.3108	0.3229
0.3098	0.3296	0.3108	0.3229	0.3119	0.3162
0.3041	0.3240	0.3055	0.3177	0.3068	0.3113
C4		C5		C6	
CIE-x	CIE-y	CIE-x	CIE-y	CIE-x	CIE-y
0.3087	0.3363	0.3098	0.3296	0.3108	0.3229
0.3146	0.3422	0.3154	0.3352	0.3162	0.3282
0.3154	0.3352	0.3162	0.3282	0.3170	0.3212
0.3098	0.3296	0.3108	0.3229	0.3119	0.3162
C7		C8		C9	
CIE-x	CIE-y	CIE-x	CIE-y	CIE-x	CIE-y
0.3146	0.3422	0.3154	0.3352	0.3162	0.3282
0.3205	0.3481	0.3210	0.3408	0.3216	0.3334
0.3210	0.3408	0.3216	0.3334	0.3221	0.3261
0.3154	0.3352	0.3162	0.3282	0.3170	0.3212

*Note

- 1) Chromaticity coordinates measurement allowance is ± 0.01 .
- 2) The Chromaticity coordinates refer to CIE 1931 chromaticity diagram.



($I_F=60\text{mA}$, $T_a=25^\circ\text{C}$)

CCT : 5,700K					
D1		D2		D3	
CIE-x	CIE-y	CIE-x	CIE-y	CIE-x	CIE-y
0.3207	0.3462	0.3212	0.3389	0.3217	0.3316
0.3263	0.3513	0.3266	0.3437	0.3268	0.3361
0.3266	0.3437	0.3268	0.3361	0.3270	0.3285
0.3212	0.3389	0.3217	0.3316	0.3222	0.3243
D4		D5		D6	
CIE-x	CIE-y	CIE-x	CIE-y	CIE-x	CIE-y
0.3263	0.3513	0.3266	0.3437	0.3268	0.3361
0.3320	0.3565	0.3319	0.3485	0.3319	0.3406
0.3319	0.3485	0.3319	0.3406	0.3318	0.3327
0.3266	0.3437	0.3268	0.3361	0.3270	0.3285
D7		D8		D9	
CIE-x	CIE-y	CIE-x	CIE-y	CIE-x	CIE-y
0.3320	0.3565	0.3319	0.3485	0.3319	0.3406
0.3376	0.3616	0.3373	0.3534	0.3369	0.3451
0.3373	0.3534	0.3369	0.3451	0.3366	0.3369
0.3319	0.3485	0.3319	0.3406	0.3318	0.3327

*Note

- 1) Chromaticity coordinates measurement allowance is ± 0.01 .
- 2) The Chromaticity coordinates refer to CIE 1931 chromaticity diagram.



($I_F=60\text{mA}$, $T_a=25^\circ\text{C}$)

CCT : 5,000K					
E1		E2		E3	
CIE-x	CIE-y	CIE-x	CIE-y	CIE-x	CIE-y
0.3376	0.3616	0.3373	0.3534	0.3369	0.3451
0.3434	0.3664	0.3428	0.3579	0.3422	0.3494
0.3428	0.3579	0.3422	0.3494	0.3416	0.3408
0.3373	0.3534	0.3369	0.3451	0.3366	0.3369
E4		E5		E6	
CIE-x	CIE-y	CIE-x	CIE-y	CIE-x	CIE-y
0.3434	0.3664	0.3428	0.3579	0.3422	0.3494
0.3493	0.3712	0.3484	0.3624	0.3474	0.3536
0.3484	0.3624	0.3474	0.3536	0.3465	0.3448
0.3428	0.3579	0.3422	0.3494	0.3416	0.3408
E7		E8		E9	
CIE-x	CIE-y	CIE-x	CIE-y	CIE-x	CIE-y
0.3493	0.3712	0.3484	0.3624	0.3474	0.3536
0.3551	0.3760	0.3539	0.3669	0.3527	0.3578
0.3539	0.3669	0.3527	0.3578	0.3515	0.3487
0.3484	0.3624	0.3474	0.3536	0.3465	0.3448

*Note

- 1) Chromaticity coordinates measurement allowance is ± 0.01 .
- 2) The Chromaticity coordinates refer to CIE 1931 chromaticity diagram.



($I_F=60\text{mA}$, $T_a=25^\circ\text{C}$)

CCT : 4,500K					
F1		F2		F3	
CIE-x	CIE-y	CIE-x	CIE-y	CIE-x	CIE-y
0.3548	0.3736	0.3536	0.3646	0.3524	0.3555
0.3611	0.3782	0.3595	0.3689	0.3580	0.3596
0.3595	0.3689	0.3580	0.3596	0.3565	0.3503
0.3536	0.3646	0.3524	0.3555	0.3512	0.3465
F4		F5		F6	
CIE-x	CIE-y	CIE-x	CIE-y	CIE-x	CIE-y
0.3611	0.3782	0.3595	0.3689	0.3580	0.3596
0.3673	0.3828	0.3655	0.3732	0.3636	0.3636
0.3655	0.3732	0.3636	0.3636	0.3617	0.3540
0.3595	0.3689	0.3580	0.3596	0.3565	0.3503
F7		F8		F9	
CIE-x	CIE-y	CIE-x	CIE-y	CIE-x	CIE-y
0.3673	0.3828	0.3655	0.3732	0.3636	0.3636
0.3736	0.3874	0.3714	0.3775	0.3692	0.3677
0.3714	0.3775	0.3692	0.3677	0.3670	0.3578
0.3655	0.3732	0.3636	0.3636	0.3617	0.3540

*Note

- 1) Chromaticity coordinates measurement allowance is ± 0.01 .
- 2) The Chromaticity coordinates refer to CIE 1931 chromaticity diagram.



($I_F=60\text{mA}$, $T_a=25^\circ\text{C}$)

CCT : 4,000K

G1		G2		G3		G4	
CIE-x	CIE-y	CIE-x	CIE-y	CIE-x	CIE-y	CIE-x	CIE-y
0.3736	0.3874	0.3720	0.3800	0.3703	0.3726	0.3687	0.3652
0.3804	0.3917	0.3785	0.3841	0.3766	0.3765	0.3746	0.3689
0.3785	0.3841	0.3766	0.3765	0.3746	0.3689	0.3727	0.3613
0.3720	0.3800	0.3703	0.3726	0.3687	0.3652	0.3670	0.3578
G5		G6		G7		G8	
CIE-x	CIE-y	CIE-x	CIE-y	CIE-x	CIE-y	CIE-x	CIE-y
0.3804	0.3917	0.3785	0.3841	0.3766	0.3765	0.3746	0.3689
0.3871	0.3959	0.3849	0.3881	0.3828	0.3803	0.3806	0.3725
0.3849	0.3881	0.3828	0.3803	0.3806	0.3725	0.3784	0.3647
0.3785	0.3841	0.3766	0.3765	0.3746	0.3689	0.3727	0.3613
G9		GA		GB		GC	
CIE-x	CIE-y	CIE-x	CIE-y	CIE-x	CIE-y	CIE-x	CIE-y
0.3871	0.3959	0.3849	0.3881	0.3828	0.3803	0.3806	0.3725
0.3939	0.4002	0.3915	0.3922	0.3890	0.3842	0.3866	0.3762
0.3915	0.3922	0.3890	0.3842	0.3866	0.3762	0.3841	0.3682
0.3849	0.3881	0.3828	0.3803	0.3806	0.3725	0.3784	0.3647
GD		GE		GF		GG	
CIE-x	CIE-y	CIE-x	CIE-y	CIE-x	CIE-y	CIE-x	CIE-y
0.3939	0.4002	0.3915	0.3922	0.3890	0.3842	0.3866	0.3762
0.4006	0.4044	0.3979	0.3962	0.3952	0.3880	0.3925	0.3798
0.3979	0.3962	0.3952	0.3880	0.3925	0.3798	0.3898	0.3716
0.3915	0.3922	0.3890	0.3842	0.3866	0.3762	0.3841	0.3682

*Note

- 1) Chromaticity coordinates measurement allowance is ± 0.01 .
- 2) The Chromaticity coordinates refer to CIE 1931 chromaticity diagram.



($I_F=60\text{mA}$, $T_a=25^\circ\text{C}$)

CCT : 3,500K

H1		H2		H3		H4	
CIE-x	CIE-y	CIE-x	CIE-y	CIE-x	CIE-y	CIE-x	CIE-y
0.3996	0.4015	0.3969	0.3932	0.3941	0.3848	0.3915	0.3769
0.4071	0.4052	0.4041	0.3969	0.4012	0.3885	0.3982	0.3803
0.4041	0.3969	0.4012	0.3885	0.3982	0.3803	0.3950	0.3721
0.3969	0.3932	0.3941	0.3848	0.3915	0.3769	0.3889	0.3690
H5		H6		H7		H8	
CIE-x	CIE-y	CIE-x	CIE-y	CIE-x	CIE-y	CIE-x	CIE-y
0.4071	0.4052	0.4041	0.3969	0.4012	0.3885	0.3982	0.3803
0.4146	0.4089	0.4114	0.4005	0.4082	0.3922	0.4050	0.3837
0.4114	0.4005	0.4082	0.3922	0.4050	0.3837	0.4017	0.3752
0.4041	0.3969	0.4012	0.3885	0.3982	0.3803	0.3950	0.3721
H9		HA		HB		HC	
CIE-x	CIE-y	CIE-x	CIE-y	CIE-x	CIE-y	CIE-x	CIE-y
0.4146	0.4089	0.4114	0.4005	0.4082	0.3922	0.4050	0.3837
0.4223	0.4127	0.4187	0.4040	0.4151	0.3953	0.4117	0.3868
0.4187	0.4040	0.4151	0.3953	0.4117	0.3868	0.4082	0.3783
0.4114	0.4005	0.4082	0.3922	0.4050	0.3837	0.4017	0.3752
HD		HE		HF		HG	
CIE-x	CIE-y	CIE-x	CIE-y	CIE-x	CIE-y	CIE-x	CIE-y
0.4223	0.4127	0.4187	0.4040	0.4151	0.3953	0.4117	0.3868
0.4299	0.4165	0.4260	0.4075	0.4221	0.3984	0.4184	0.3899
0.4260	0.4075	0.4221	0.3984	0.4184	0.3899	0.4147	0.3814
0.4187	0.4040	0.4151	0.3953	0.4117	0.3868	0.4082	0.3783

*Note

- 1) Chromaticity coordinates measurement allowance is ± 0.01 .
- 2) The Chromaticity coordinates refer to CIE 1931 chromaticity diagram.



($I_F=60\text{mA}$, $T_a=25^\circ\text{C}$)

CCT : 3,000K

I1		I2		I3		I4	
CIE-x	CIE-y	CIE-x	CIE-y	CIE-x	CIE-y	CIE-x	CIE-y
0.4299	0.4165	0.4260	0.4075	0.4221	0.3984	0.4184	0.3899
0.4364	0.4189	0.4323	0.4098	0.4282	0.4008	0.4243	0.3921
0.4323	0.4098	0.4282	0.4008	0.4243	0.3921	0.4203	0.3834
0.4260	0.4075	0.4221	0.3984	0.4184	0.3899	0.4147	0.3814
I5		I6		I7		I8	
CIE-x	CIE-y	CIE-x	CIE-y	CIE-x	CIE-y	CIE-x	CIE-y
0.4364	0.4189	0.4323	0.4098	0.4282	0.4008	0.4243	0.3921
0.4430	0.4212	0.4387	0.4122	0.4344	0.4032	0.4302	0.3943
0.4387	0.4122	0.4344	0.4032	0.4302	0.3943	0.4260	0.3853
0.4323	0.4098	0.4282	0.4008	0.4243	0.3921	0.4203	0.3834
I9		IA		IB		IC	
CIE-x	CIE-y	CIE-x	CIE-y	CIE-x	CIE-y	CIE-x	CIE-y
0.4430	0.4212	0.4387	0.4122	0.4344	0.4032	0.4302	0.3943
0.4496	0.4236	0.4450	0.4144	0.4404	0.4052	0.4360	0.3962
0.4450	0.4144	0.4404	0.4052	0.4360	0.3962	0.4316	0.3873
0.4387	0.4122	0.4344	0.4032	0.4302	0.3943	0.4260	0.3853
ID		IE		IF		IG	
CIE-x	CIE-y	CIE-x	CIE-y	CIE-x	CIE-y	CIE-x	CIE-y
0.4496	0.4236	0.4450	0.4144	0.4404	0.4052	0.4360	0.3962
0.4562	0.4260	0.4513	0.4166	0.4465	0.4071	0.4419	0.3982
0.4513	0.4166	0.4465	0.4071	0.4419	0.3982	0.4373	0.3894
0.4450	0.4144	0.4404	0.4052	0.4360	0.3962	0.4316	0.3873

*Note

- 1) Chromaticity coordinates measurement allowance is ± 0.01 .
- 2) The Chromaticity coordinates refer to CIE 1931 chromaticity diagram.



($I_F=60\text{mA}$, $T_a=25^\circ\text{C}$)

CCT : 2,700K

J1		J2		J3		J4	
CIE-x	CIE-y	CIE-x	CIE-y	CIE-x	CIE-y	CIE-x	CIE-y
0.4562	0.4260	0.4513	0.4166	0.4465	0.4071	0.4419	0.3982
0.4625	0.4275	0.4575	0.4181	0.4525	0.4087	0.4477	0.3996
0.4575	0.4181	0.4525	0.4087	0.4477	0.3996	0.4428	0.3906
0.4513	0.4166	0.4465	0.4071	0.4419	0.3982	0.4373	0.3893
J5		J6		J7		J8	
CIE-x	CIE-y	CIE-x	CIE-y	CIE-x	CIE-y	CIE-x	CIE-y
0.4625	0.4275	0.4575	0.4181	0.4525	0.4087	0.4477	0.3996
0.4687	0.4289	0.4637	0.4196	0.4586	0.4103	0.4535	0.4011
0.4637	0.4196	0.4586	0.4103	0.4535	0.4011	0.4483	0.3918
0.4575	0.4181	0.4525	0.4087	0.4477	0.3996	0.4426	0.3906
J9		JA		JB		JC	
CIE-x	CIE-y	CIE-x	CIE-y	CIE-x	CIE-y	CIE-x	CIE-y
0.4687	0.4289	0.4637	0.4196	0.4586	0.4103	0.4535	0.4011
0.4750	0.4304	0.4697	0.4209	0.4643	0.4115	0.4590	0.4023
0.4697	0.4209	0.4643	0.4115	0.4590	0.4023	0.4538	0.3931
0.4637	0.4196	0.4586	0.4103	0.4535	0.4011	0.4483	0.3918
JD		JE		JF		JG	
CIE-x	CIE-y	CIE-x	CIE-y	CIE-x	CIE-y	CIE-x	CIE-y
0.4750	0.4304	0.4697	0.4209	0.4643	0.4115	0.4590	0.4023
0.4813	0.4319	0.4756	0.4223	0.4700	0.4126	0.4646	0.4035
0.4756	0.4223	0.4700	0.4126	0.4646	0.4035	0.4593	0.3944
0.4697	0.4209	0.4643	0.4115	0.4590	0.4023	0.4538	0.3931

*Note

- 1) Chromaticity coordinates measurement allowance is ± 0.01 .
- 2) The Chromaticity coordinates refer to CIE 1931 chromaticity diagram.



($I_F=60\text{mA}$, $T_a=25^\circ\text{C}$)

CCT : 2,500K

K1		K2		K3		K4	
CIE-x	CIE-y	CIE-x	CIE-y	CIE-x	CIE-y	CIE-x	CIE-y
0.4758	0.4225	0.4703	0.4132	0.4648	0.4038	0.4593	0.3944
0.4813	0.4319	0.4758	0.4225	0.4703	0.4132	0.4648	0.4038
0.4876	0.4326	0.4819	0.4232	0.4763	0.4138	0.4706	0.4044
0.4819	0.4232	0.4763	0.4138	0.4706	0.4044	0.4649	0.3950
K5		K6		K7		K8	
CIE-x	CIE-y	CIE-x	CIE-y	CIE-x	CIE-y	CIE-x	CIE-y
0.4819	0.4232	0.4763	0.4138	0.4706	0.4044	0.4649	0.3950
0.4876	0.4326	0.4819	0.4232	0.4763	0.4138	0.4706	0.4044
0.4939	0.4332	0.4881	0.4238	0.4822	0.4144	0.4764	0.4050
0.4881	0.4238	0.4822	0.4144	0.4764	0.4050	0.4705	0.3956
K9		KA		KB		KC	
CIE-x	CIE-y	CIE-x	CIE-y	CIE-x	CIE-y	CIE-x	CIE-y
0.4881	0.4238	0.4822	0.4144	0.4764	0.4050	0.4705	0.3956
0.4939	0.4332	0.4881	0.4238	0.4822	0.4144	0.4764	0.4050
0.5002	0.4339	0.4942	0.4244	0.4882	0.4150	0.4821	0.4056
0.4942	0.4244	0.4882	0.4150	0.4821	0.4056	0.4761	0.3962
KD		KE		KF		KG	
CIE-x	CIE-y	CIE-x	CIE-y	CIE-x	CIE-y	CIE-x	CIE-y
0.4942	0.4244	0.4882	0.4150	0.4821	0.4056	0.4761	0.3962
0.5002	0.4339	0.4942	0.4244	0.4882	0.4150	0.4821	0.4056
0.5065	0.4345	0.5003	0.4251	0.4941	0.4157	0.4879	0.4062
0.5003	0.4251	0.4941	0.4157	0.4879	0.4062	0.4817	0.3968

*Note

- 1) Chromaticity coordinates measurement allowance is ± 0.01 .
- 2) The Chromaticity coordinates refer to CIE 1931 chromaticity diagram.



($I_F=60\text{mA}$, $T_a=25^\circ\text{C}$)

CCT : 2,200K

L1		L2		L3		L4	
CIE-x	CIE-y	CIE-x	CIE-y	CIE-x	CIE-y	CIE-x	CIE-y
0.5003	0.4251	0.4941	0.4157	0.4879	0.4062	0.4817	0.3968
0.5065	0.4345	0.5003	0.4251	0.4941	0.4157	0.4879	0.4062
0.5128	0.4340	0.5066	0.4246	0.5004	0.4152	0.4942	0.4057
0.5066	0.4246	0.5004	0.4152	0.4942	0.4057	0.4880	0.3963
L5		L6		L7		L8	
CIE-x	CIE-y	CIE-x	CIE-y	CIE-x	CIE-y	CIE-x	CIE-y
0.5066	0.4246	0.5004	0.4152	0.4942	0.4057	0.4880	0.3963
0.5128	0.4340	0.5066	0.4246	0.5004	0.4152	0.4942	0.4057
0.5190	0.4335	0.5128	0.4241	0.5066	0.4147	0.5004	0.4052
0.5128	0.4241	0.5066	0.4147	0.5004	0.4052	0.4942	0.3958
L9		LA		LB		LC	
CIE-x	CIE-y	CIE-x	CIE-y	CIE-x	CIE-y	CIE-x	CIE-y
0.5128	0.4241	0.5066	0.4147	0.5004	0.4052	0.4942	0.3958
0.5190	0.4335	0.5128	0.4241	0.5066	0.4147	0.5004	0.4052
0.5253	0.4330	0.5191	0.4236	0.5129	0.4142	0.5067	0.4047
0.5191	0.4236	0.5129	0.4142	0.5067	0.4047	0.5005	0.3953
LD		LE		LF		LG	
CIE-x	CIE-y	CIE-x	CIE-y	CIE-x	CIE-y	CIE-x	CIE-y
0.5191	0.4236	0.5129	0.4142	0.5067	0.4047	0.5005	0.3953
0.5253	0.4330	0.5191	0.4236	0.5129	0.4142	0.5067	0.4047
0.5315	0.4325	0.5253	0.4231	0.5191	0.4137	0.5129	0.4042
0.5253	0.4231	0.5191	0.4137	0.5129	0.4042	0.5067	0.3948

*Note

- 1) Chromaticity coordinates measurement allowance is ± 0.01 .
- 2) The Chromaticity coordinates refer to CIE 1931 chromaticity diagram.



($I_F=60\text{mA}$, $T_a=25^\circ\text{C}$)

CCT : 2,000K

M1		M2		M3		M4	
CIE-x	CIE-y	CIE-x	CIE-y	CIE-x	CIE-y	CIE-x	CIE-y
0.5253	0.4231	0.5191	0.4137	0.5129	0.4042	0.5067	0.3948
0.5315	0.4325	0.5253	0.4231	0.5191	0.4137	0.5129	0.4042
0.5378	0.4319	0.5316	0.4225	0.5254	0.4130	0.5192	0.4036
0.5316	0.4225	0.5254	0.4130	0.5192	0.4036	0.5130	0.3942
M5		M6		M7		M8	
CIE-x	CIE-y	CIE-x	CIE-y	CIE-x	CIE-y	CIE-x	CIE-y
0.5316	0.4225	0.5254	0.4130	0.5192	0.4036	0.5130	0.3942
0.5378	0.4319	0.5316	0.4225	0.5254	0.4130	0.5192	0.4036
0.5440	0.4313	0.5378	0.4218	0.5316	0.4124	0.5254	0.4030
0.5378	0.4218	0.5316	0.4124	0.5254	0.4030	0.5192	0.3936
M9		MA		MB		MC	
CIE-x	CIE-y	CIE-x	CIE-y	CIE-x	CIE-y	CIE-x	CIE-y
0.5378	0.4218	0.5316	0.4124	0.5254	0.4030	0.5192	0.3936
0.5440	0.4313	0.5378	0.4218	0.5316	0.4124	0.5254	0.4030
0.5503	0.4306	0.5441	0.4212	0.5379	0.4118	0.5317	0.4024
0.5441	0.4212	0.5379	0.4118	0.5317	0.4024	0.5255	0.3929
MD		ME		MF		MG	
CIE-x	CIE-y	CIE-x	CIE-y	CIE-x	CIE-y	CIE-x	CIE-y
0.5441	0.4212	0.5379	0.4118	0.5317	0.4024	0.5255	0.3929
0.5503	0.4306	0.5441	0.4212	0.5379	0.4118	0.5317	0.4024
0.5565	0.4300	0.5503	0.4206	0.5441	0.4112	0.5379	0.4017
0.5503	0.4206	0.5441	0.4112	0.5379	0.4017	0.5317	0.3923

*Note

- 1) Chromaticity coordinates measurement allowance is ± 0.01 .
- 2) The Chromaticity coordinates refer to CIE 1931 chromaticity diagram.



7. Results of Reliability Tests

(1) Static Electricity

Test Item	Standard	Test Condition	Notes	No. of Damaged
Temperature Cycle	JEITA ED-4701 100 105	-40°C~25°C ~ 100°C~25°C (30min~5min~30min)	100 cycle	0/22
Steady State Operating Life		$T_a=25^{\circ}\text{C}$, $I_F=100\text{mA}$	1,000 hrs	0/22
Steady State Operating Life of High Temperature		$T_a=85^{\circ}\text{C}$, $I_F=60\text{mA}$	1,000 hrs	0/22
Steady State Operating Life of high Humidity Heat		$T_a=60^{\circ}\text{C}$, RH=90%, $I_F=50\text{mA}$	500 hrs	0/22
High Temperature Storage	JEITA ED-4701 200 201	$T_a=100^{\circ}\text{C}$	1,000 hrs	0/22
High Temperature & Humidity Storage	JEITA ED-4701 100 103	$T_a=60^{\circ}\text{C}$, RH=90%	1,000 hrs	0/22
Low Temperature Storage	JEITA ED-4701 200 202	$T_a=-40^{\circ}\text{C}$	1,000 hrs	0/22
Resistance to Soldering Heat	JEITA ED-4701 300 301	$T_{\text{max}}=260^{\circ}\text{C}$, 10sec	2 time	0/22

8. Soldering Cautions

- * Reflow soldering should not be done more than two times.
- * When soldering, do not put stress on the LEDs during heating.
- * After soldering, do not wrap the circuit board.
- * The LEDs can be soldered on place using the reflow soldering method.
- * Occasionally, there is decrease in brightness caused by the influence of heat or ambient atmosphere during air reflow.
- * It is recommended that the user use the nitrogen reflow method.

■ Reflow Soldering Profile

1) Lead Solder

Lead Solder	
Pre-heat	120~150°C
Pre-heat time	120 sec. Max.
Peak-Temperature	240°C Max
Soldering time Condition	10 sec. Max.

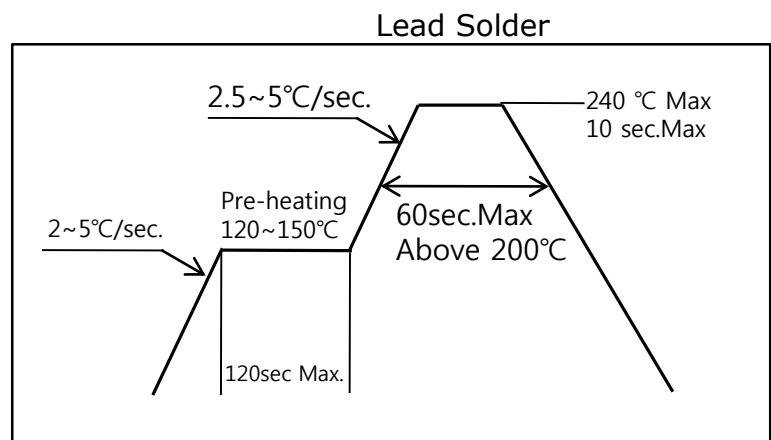

2) Lead-Free Solder

Lead Solder	
Pre-heat	180~200°C
Pre-heat time	120 sec. Max.
Peak-Temperature	260°C Max
Soldering time Condition	5 sec. Max.

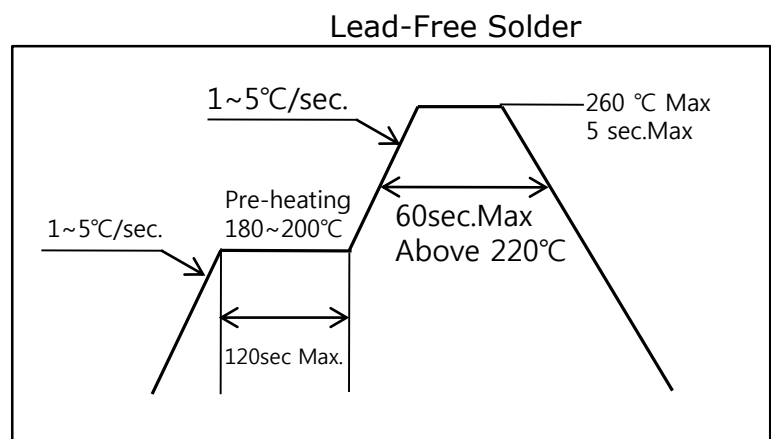

9. Precautions

(1) Storage

1. After opening the moisture-proof aluminum bag, the soldering process should be performed within the range of the following condition. Unused remaining LEDs should be stored with silica gel desiccants in a sealed container, preferably the moisture-proof bags for storage. Included silica gel desiccants change from orange to green if moisture had penetrated bags.

Conditions		Humidity	Temperature	Time
Storage	Before opening Aluminum Bag	≤30°C	≤90%RH	Within 1 year from Delivery Date
	After opening Aluminum Bag	≤30°C	≤70%RH	≤168hours
Baking		65±5°C	-	≥24hours

2. After the storage time after opening has been exceeded or silica gel desiccants are no longer orange, the products should be baked. Baking should only be done once.
3. Products should be packed in moisture-proof aluminum bag to minimize moisture absorption during transportation and storage. Absorbed moisture can cause delamination of interface and result in optical performance degradation.
4. Customers are advised to keep the LEDs in an airtight container when not using. Exposing LEDs to a corrosive environment may cause the plated metal parts of the product to tarnish, which could have harmful influence on soldering and optical characteristics.
5. After assembly and during use, silver plating can be affected by the corrosive gases released by materials and components close to the LEDs within an end product, and the gases entering into the product from the external atmosphere. Resin materials, particularly, may contain substances which can affect silver plating, such as halogen.



6. To prevent water condensation, please avoid large fluctuation of temperature and humidity for the storage conditions.
7. Do not make the LEDs exposed to direct sunlight or/and to an environment where the temperature is higher than that of normal rooms.

(2) Electrostatic Discharge(ESD)

1. Ensure that tools jigs and machines that are used are properly grounded and that proper grounding techniques are used in work place. Protection against surge voltages should also be used for devices or equipment which mount the LEDs.
2. If tools or equipment contain insulating materials such as glass or plastic, the following measures against electrostatic discharge are recommended :
 - Dissipating static charge with conductive materials
 - Preventing charge generation with moisture
 - Neutralizing the charge with ionizers

(3) Storage

1. The current through each LED must not exceed the Absolute Maximum Rating when designing a circuit.
2. Make sure that excessive voltages such as lightning surges are not applied to the LEDs.
3. This product should be operated using forward current. When used in displays that are not used for a long time, the main power supply should be switched off for safety.
4. For outdoor use, necessary measures should be taken to prevent water, moisture and salt air damage.



(4) Handling Precaution

1. Do not handle the LEDs with bare hands because it will contaminate the LED surface and may affect the optical characteristics. It might cause the LED to be deformed and/or the wire to break, causing the LED not to illuminate.
2. Be careful not to drop the product, which can cause damage.
3. When handling the product with tweezers, be careful not to apply excessive force to the resin.
4. Do not stack assembled PCBs together. Failure to comply can cause the resin portion of the product to be cut, chipped, delaminated and/or deformed. It may cause wire to break, leading to failures.

(5) Thermal Management

1. Proper thermal management is important when designing product with LEDs. LED die temperature is affected by PCB thermal resistance and LED spacing on the board. Please design products in a way that the LED die temperature does not exceed the maximum Junction Temperature.
2. To dissipate the heat from the product, drive current should be determined for the surrounding ambient temperature.

(6) Cleaning

1. The LEDs should not be cleaned with water, benzene, or thinner.
2. When dust and/or dirt adheres to the LEDs, soak a cloth with isopropyl alcohol (IPA), then squeeze it before wiping the LEDs.
3. Isopropyl alcohol(IPA) should be used if necessary. Other solvents may cause failure to the LEDs due to the damage to the resin portion. The effects of such solvents should be certified prior to use. In addition, the use of CFCs is heavily regulated.



(7) Design Consideration

1. PCB warpage after the products are mounted onto a PCB can make the package to break. The LED should be placed in a way to minimize the force on the LEDs due to PCB bow and twist.
2. Board separation should not be performed using hands, but using special jigs.
3. The position and orientation of the LEDs affect how much mechanical stress is exerted on the LEDs placed near the score lines. The LED should be placed in a way to minimize the force on the LEDs due to board fixing.
4. Volatile organic compounds that have been released from material around the LEDs may penetrate the LED lens and/or encapsulating resin.

If the LEDs are being used in a sealed environment, these volatile compounds can discolor after being exposed to heat and/or photon energy and it may greatly reduce the LED light output and/or cause a color shift.

In this case, ventilating the environment may improve the reduction in light output and/or color shift.

Perform a light-up test of the chosen application for optical evaluation to ensure that there are no issues, especially if the LEDs are planned to be used in a sealed environment.



(8) Others

1. The LEDs described in this brochure are intended to be used for ordinary electronic equipment (such as household appliances, office equipment, communications equipment, and measurement instruments.)
2. When defective LEDs are found, the customer shall inform ALLIX before disassembling or analysis.
3. Contact in advance ALLIX's sales staff for information on the applications in which exceptional quality and reliability are required, in particular when the malfunction or failure of the LEDs may directly threat life or health (such as airplanes, aerospace, automobiles, submersible repeaters, traffic control equipment, nuclear reactor control system, and safety devices).
4. The specifications and appearance of this product may change without notice. ALLIX does not guarantee the contents of this specification. Both the customer and ALLIX will agree on the official specifications of supplied products before the volume production of a program begins.



10. Outline Dimension

■ Outline Dimension

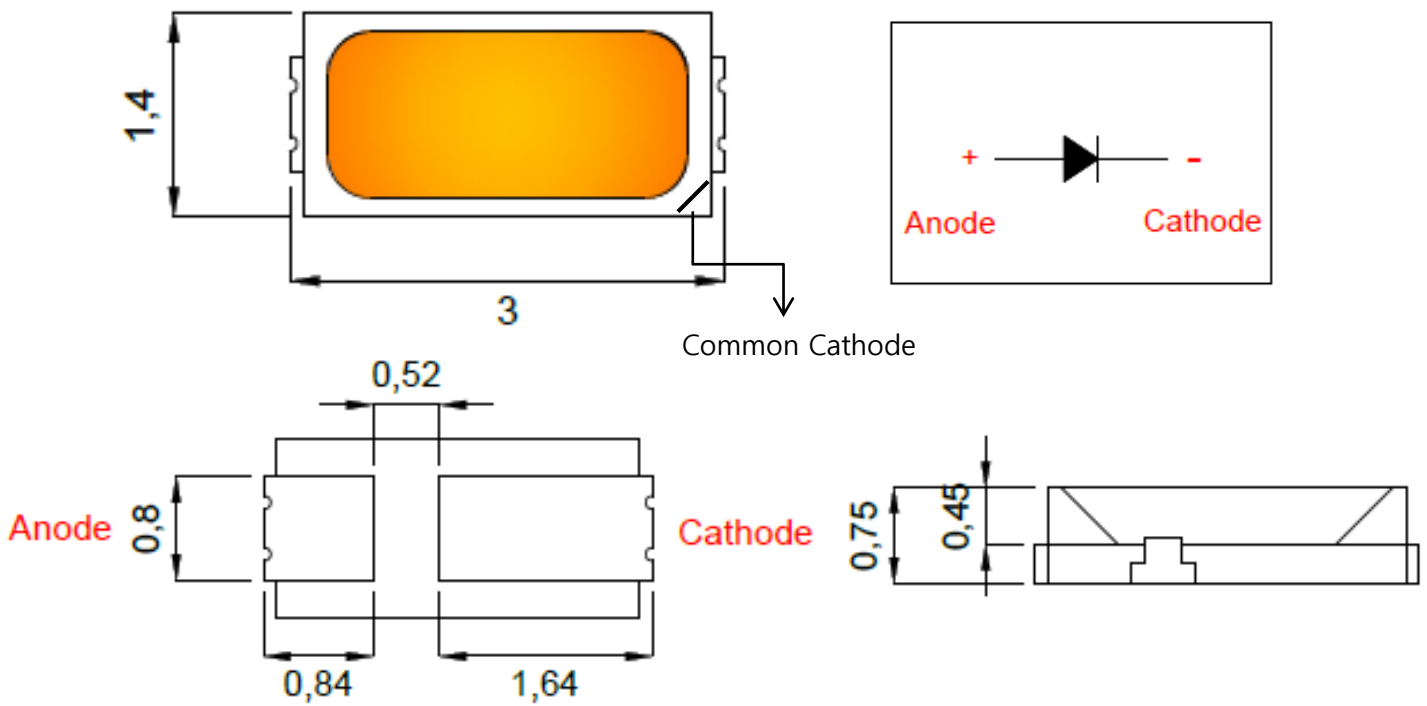

■ Soldering Pad

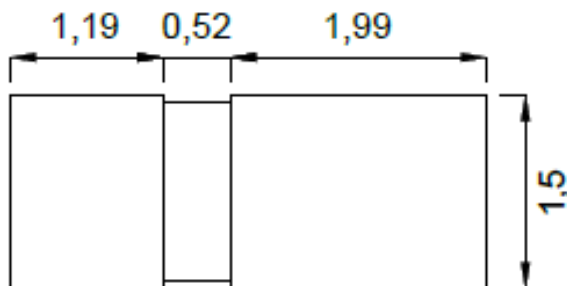

11. Composition of Package

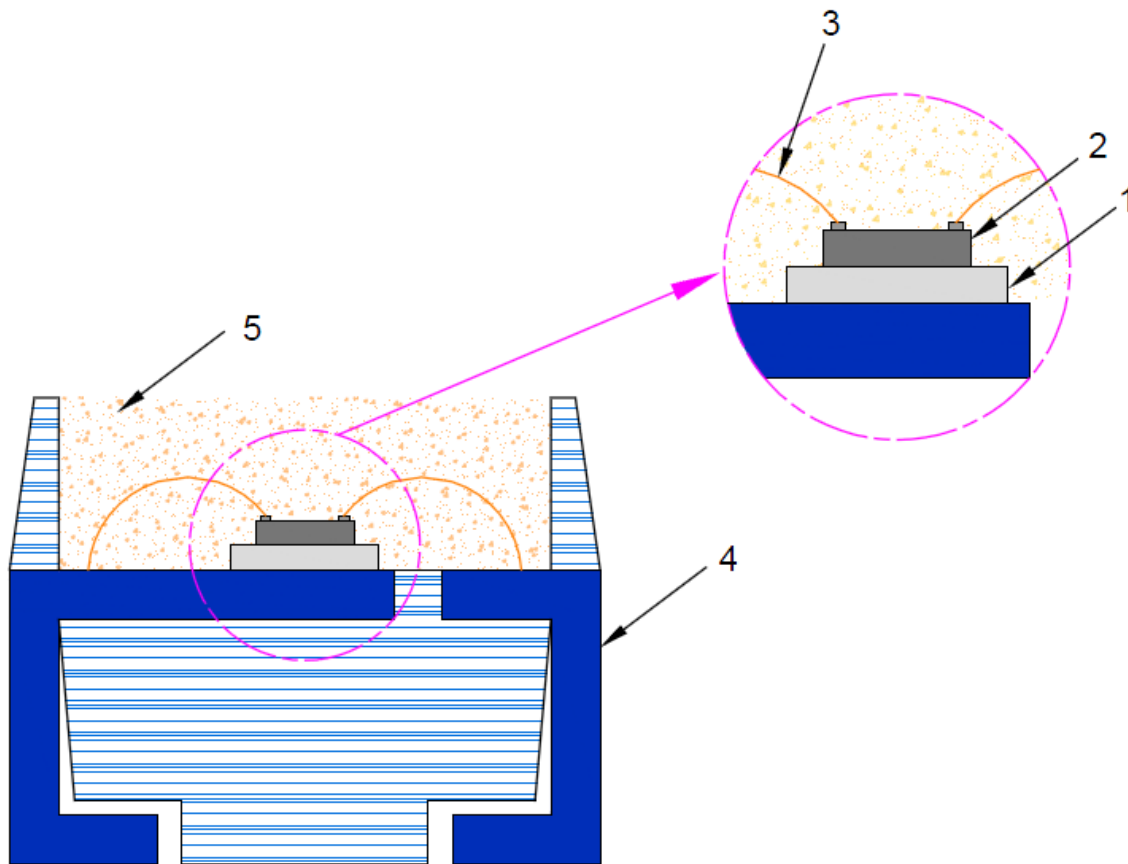

No.	Item	Material
1	Die Paste	Ag Epoxy or Silicone
2	Chip	InGaN
3	Au Wire	1.0 ~ 1.2mil
4	Lead Frame	Cu Strike Ag
5	Potting Resin	Silicone

12. Taping

■ Dimension of Reel

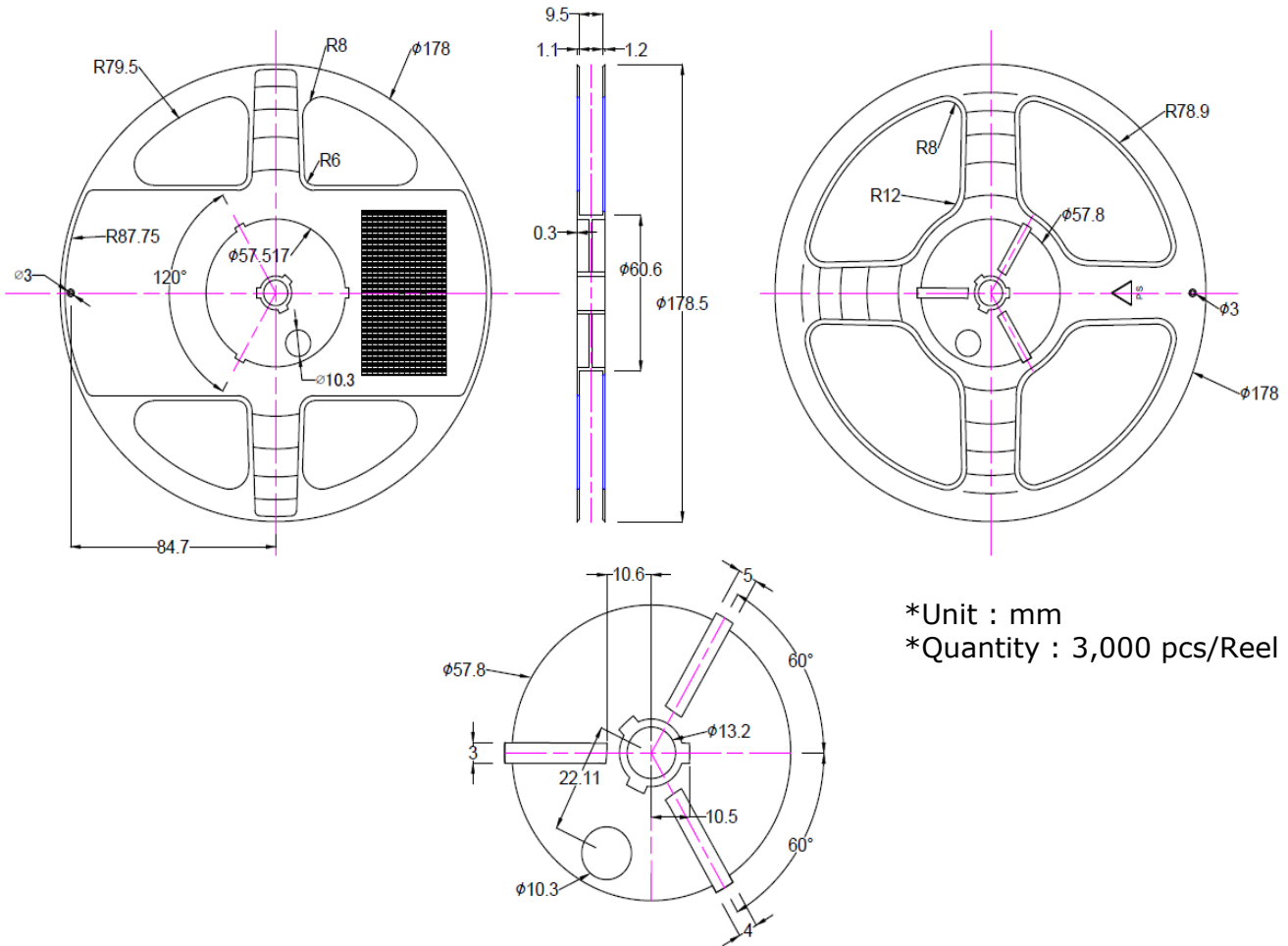

*Unit : mm

*Quantity : 3,000 pcs/Reel

■ Dimension of Tape

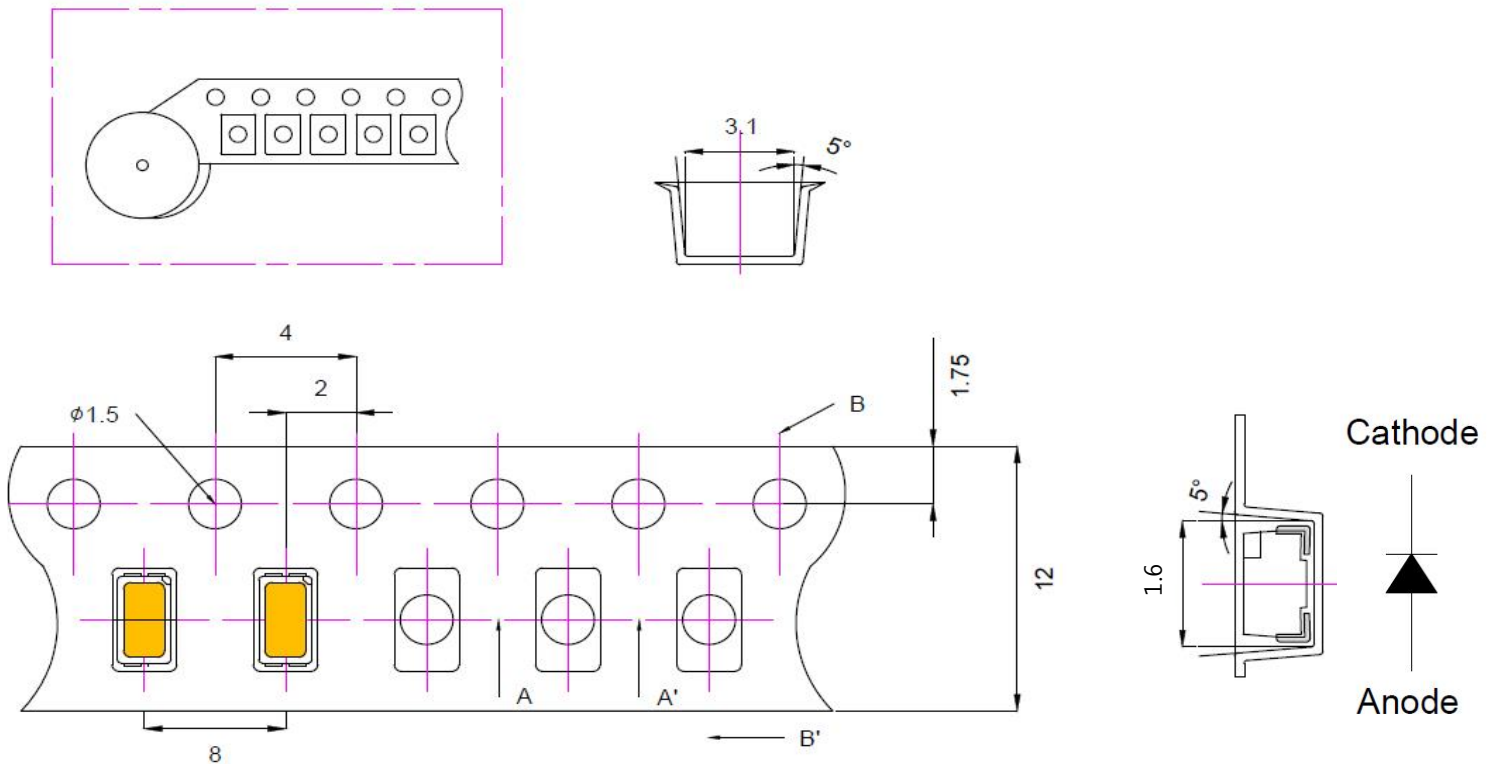

13. Packing Structure

